

INSTRUCTION MANUAL

Wood Cutting 14 " Band Saw

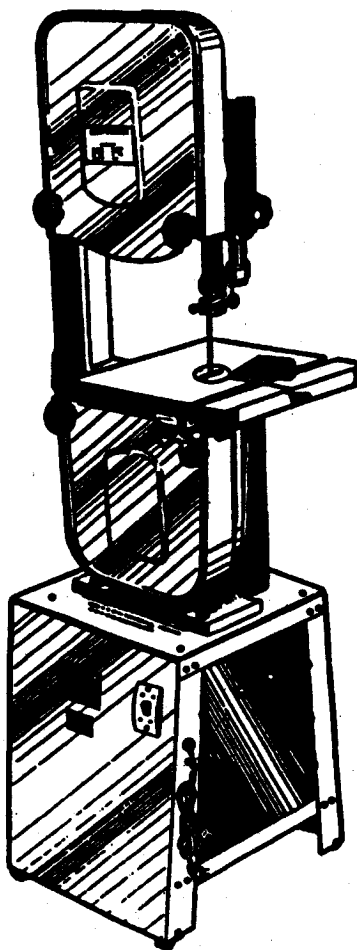

This band saw can offer you a series of various speed from single, two, four to five that fits for different demands of working.

Before Using Be Sure To Read This Manual.

SAFETY RULES

1. **KEEP GUARDS IN PLACE** and in working order.
2. **REMOVE ADJUSTING KEYS AND WRENCHES.**
Form habit of checking to see that keys and adjusting wrenches are removed from tool before turning it on.
3. **KEEP WORK AREA CLEAN.** Cluttered areas and benches invite accidents.
4. **DON'T USE IN DANGEROUS ENVIRONMENT.**
Don't use power tools in damp or wet location, or expose them to rain. Keep work area well lighted.
5. **KEEP CHILDREN AWAY.** All visitors should be kept safe distance from work area.
6. **MAKE WORKSHOP KID PROOF.** With padlocks, master switches, or by removing starter keys.
7. **DON'T FORCE TOOL.** Don't force tool or attachment to do a job for which it was not designed.
8. **USE RIGHT TOOL.** It will do the job better and safer at the rate for which it was designed.
9. **WEAR PROPER APPAREL.** No loose clothing, gloves, neckties, rings, bracelets, or other jewelry to get caught in moving parts. Nonslip footwear is recommended. Wear protective hair covering to contain long hair.
10. **ALWAYS USE SAFETY GLASSES.** Also use face or dust mask if cutting operation is dusty. Everyday eyeglasses only have impact resistant lenses, they are NOT safety glasses.
11. **SECURE WORK.** Use clamps or a vise to hold work when practical. It's safer than using your hand and it frees both hands to operate tool.
12. **DON'T OVERREACH.** Keep proper footing and balance at all times.
13. **MAINTAIN TOOLS WITH CARE.** Keep tools sharp and clean for best and safest performance. Follow instructions for lubricating and changing accessories.
14. **DISCONNECT TOOLS** before servicing; when changing accessories such as blades.
15. **REDUCE THE RISK OF UNINTENTIONAL STARTING.** Make sure switch is in off position before plugging in.
16. **USE RECOMMENDED ACCESSORIES.** Consult the owner's manual for recommended accessories. The use of improper accessories may cause risk of injury to persons.
17. **NEVER STAND ON TOOL.** Serious injury could occur if the tool is tipped or if the cutting tool is unintentionally contacted.
18. **CHECK DAMAGED PARTS.** Before further use of the tool, a guard or other part that is damaged should be carefully checked to determine that it will operate properly and perform its intended function — check for alignment of moving parts, binding of moving parts, breakage of parts, mounting, and any other conditions that may affect its operation. A guard or other part that is damaged should be properly repaired or replaced.
19. **DIRECTION OF FEED.** Feed work into a blade or cutter against the direction of rotation of the blade or cutter only
20. **NEVER LEAVE TOOL RUNNING UNATTENDED**
TURN POWER OFF. Don't leave tool until it comes to a complete stop.

SPECIAL SAFETY RULES FOR BAND SAWS

1. **ADJUST** the upper guide about 1/8" (3.2mm) above the material being cut.
2. **MAKE SURE** that blade tension and blade tracking are properly adjusted.
3. **STOP** the machine before removing scrap pieces from the table.
4. **ALWAYS** keep hands and fingers away from blade.
5. **CHECK** for proper blade size and type.
6. **DO NOT** attempt to saw stock that does not have a flat surface, unless a suitable support is used.
7. **HOLD** material firmly and feed into blade at a moderate speed.
8. **TURN OFF** machine if the material is to be backed out of an uncompleted cut.
9. **MAKE "relief" cuts** before cutting long curves.

GROUNDING INSTRUCTIONS

1. In the event of a malfunction or breakdown, grounding provides a path of least resistance for electric current to reduce the risk of electric shock. This tool is equipped with an electric cord having an equipment - grounding conductor and a grounding plug. The plug must be plugged into a matching outlet that is properly installed and grounded in accordance with all local codes and ordinances.
2. Do not modify the plug provided it will not fit the outlet, have the proper outlet installed by a qualified electrician.
3. Improper connection of the equipment grounding conductor can result in a risk of electric shock. The conductor with insulation having an outer surface that is green with or without yellow stripe is the equipment - grounding conductor. If repair or replacement of the electric cord or plug is necessary, do not connect the equipment - grounding conductor to a live terminal.
4. Check with a qualified electrician or serviceman if the grounding instructions are not completely understood, or if in doubt as to whether the tool is properly grounded.
5. Use only 3 - wire extension cords that have 3 - prong grounding plugs and 3 - pole receptacles that accept the tool's plug.
6. Repair or replace damaged or worn cord immediately.
7. This tool is intended for use on a circuit that has an outlet that looks like the one illustrated in sketch A. The tool has a grounding plug that looks like the plug illustrated in sketch A. A temporary adapter, which looks like the adapter illustrated in sketches B and C, may be used to connect his plug to a 2 pole receptable as shown in sketch B if a properly grounded outlet is not available. The temporary adapter should be used only until a properly grounded outlet can be installed by a qualified electrician. The green - colored rigid ear, lug, etc. extending from the adapter must be connected to a permanent ground such as a properly grounded outlet box.

Note:

The type of electrical plug and receptacle differs from country to country.

Caution:

In Canada only the grounding shown in figure (A) is acceptable. The extension cords should be CSA certified S. J. T. type or something better.

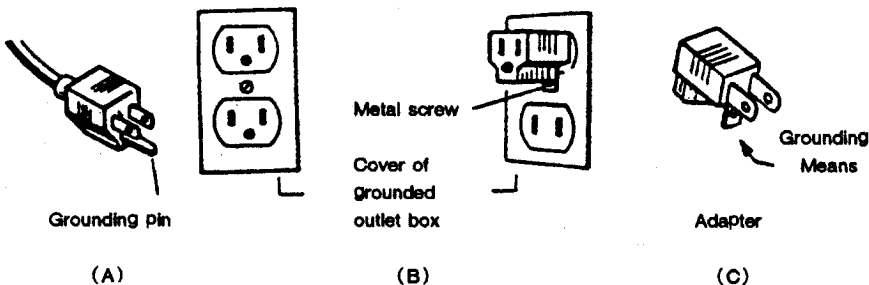

POWER CONNECTIONS

A separate electrical circuit should be used for the power tools. This circuit should not be less than No. 12 wire and should be protected with a 20 Amp. time lag fuse. Never use long extension cords. If an extension cord is used, use only 3 - wire extension cords which have 3 - prong grounding type plugs and 3 - pole receptacles which accept the tool plug. Before connecting the motor to the power line, be sure that the electric current is of the same characteristics as stamped on motor nameplate. All line connections should make good contact. Running on low voltage will damage the motor.

UNPACKING

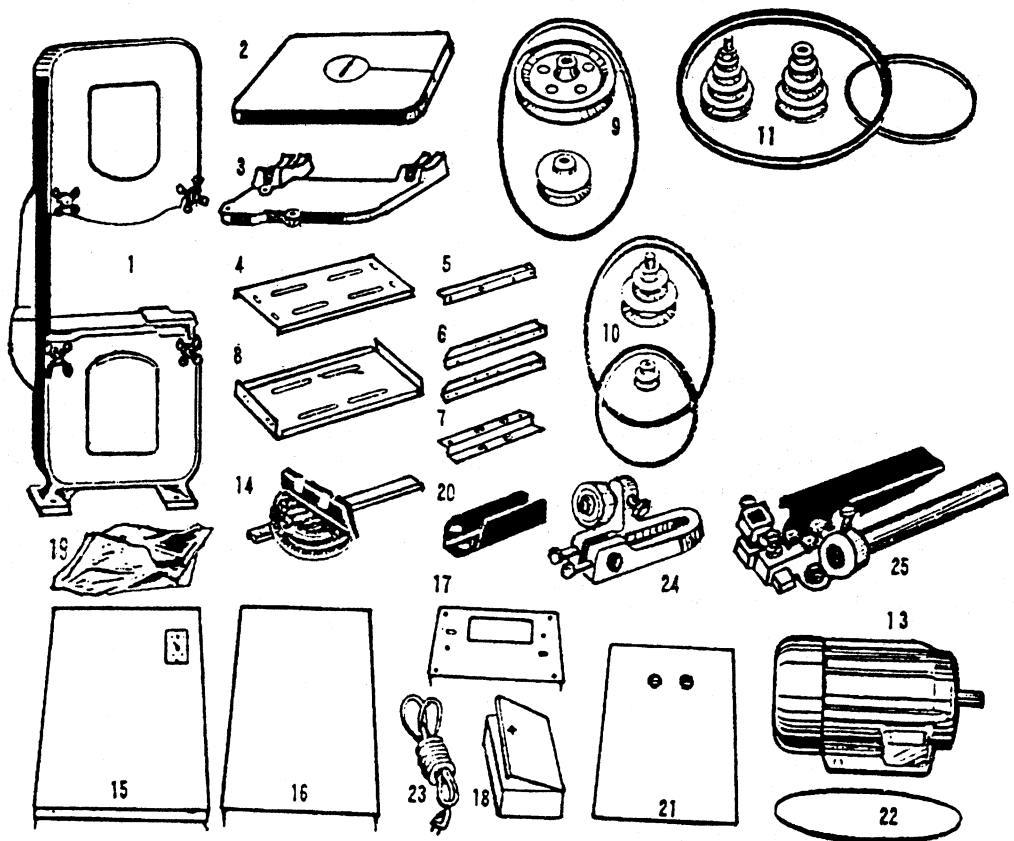

Carefully unpack the band saw and check all items, Figure 1, illustrates the contents of the carton. Do not discard any packing material until the band saw is fully assembled operational.

- | | |
|-----------------------------------|---------------------------------------|
| 1. Bandsaw Main Frame | 14. Miter Gauge |
| 2. Table | 15. Stand Leg W/Switch Hole |
| 3. Trunnion Bracket | 16. Stand Leg |
| 4. Base Motor Plate | 17. Top of stand |
| 5. Supporting Bar | 18. Pulley Guard |
| 6. Supporting Plates, Stand | 19. Hardware Package. |
| 7. Motor Supporting Bar | 20. Guard For Upper Guide Post |
| 8. Motor Fastening Plate | 21. Retaining Plate |
| 9. Pulley & V-Belt (Single Speed) | 22. Saw Blade |
| 10. Pulley & V-Belt (Two Speed) | 23. Motor's Lead Wire |
| 11. Pulley & V-Belt (Four Speed) | 24. Set of Lower Support Bracket Post |
| | 25. Set of Upper S. B. P. |
| 13. Motor | |

Caution

All No. 9. 10. 11. 12 in Figure (1) is different accessories according to different Types of machines (single speed - five speed).

ASSEMBLY OF LEG STAND

(All parts Numbers please refer to Fig.1)

Using supporting plates (#6). and base motor plate (#4) to form the basic construction of the stand and tighten them together. Fig. 2.

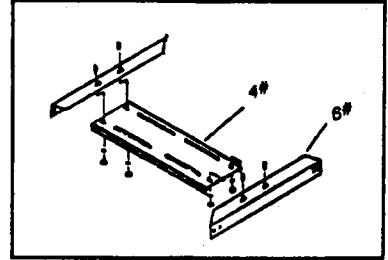

Fig. 2

Fasten the motor fastening plate (#8) on the base motor plate (#4) vertically. Watch the plate (#8) carefully on the face you can divide it into two parts. Using the 4 slots as the divider. one end is larger and the other smaller. Make sure that the larger end is mounted upward on the motor plate. After then, mount the motor supporting bar (#7) on the motor fastening plate (#8).

Note that the side with 4 holes must mount on the motor supporting bar, not the side with 16 holes. Fig.3.

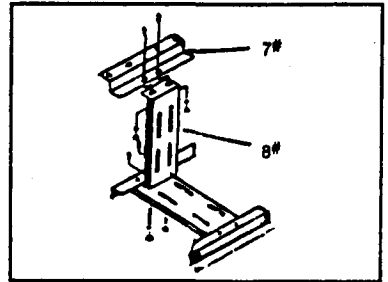

Fig. 3

Fix the two stand leg (#15 & #16) on both sides and the stand leg w/switch hole (#15) must on the left hand side. Fig. 4.

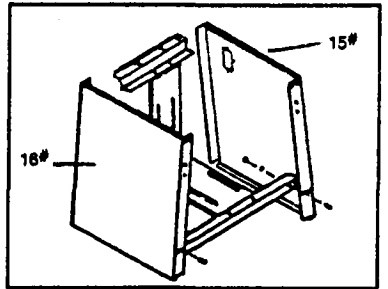

Fig. 4

Install the top of stand (#17) on top and remember that the motor mounting hole and the switch hole of stand leg are on opposite side. Fig.5.

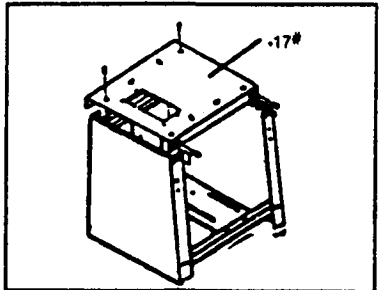

Fig. 5

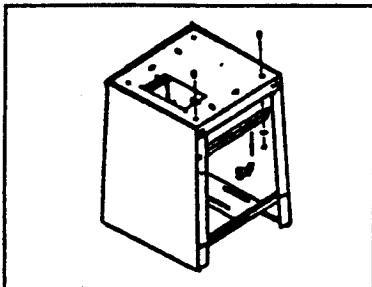

Fig. 6

Finally, fix the supporting bar (#5) below the top of stand (#17).
Completed leg stand.

Please Remember to Tighten all screws and check that if the stand is firm enough. Fig. 6.

Refer to direction of Fig. 7. mount the foot pads on four corners of the leg stand in order to increase the machine's stability.

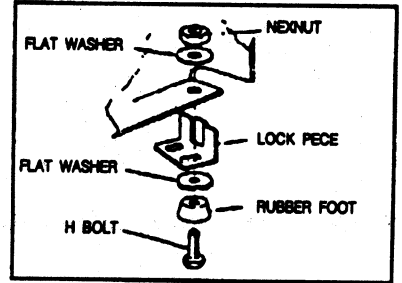

Fig. 7

ASSEMBLY AND ADJUSTMENT

Stand installation

Use attached screws, washers to fix legs, top and supporting plate firmly. Fig. 8.

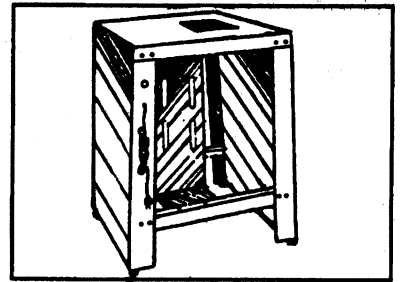

Fig. 8

Motor installation

Fix base plate and motor fastening plate first. Install motor on it's fastening plate roughly, because further precise adjustment will be required. Fig. 9.

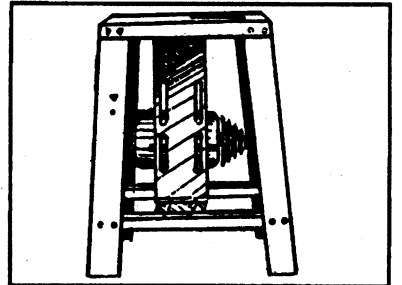

Fig. 9

Assemble the motor mounting plate (A) Fig. 10. using the two hex head cap screws, flat washers and nuts (B). The other end of the motor plate is fastened to the side of cabinet using a camage bolt from the outside of the cabinet and a flat washer and nut on the inside.

Attach the motor to the motor mounting plate as shown in Fig. 10. using the four camage bolts, flat washers and square nuts.

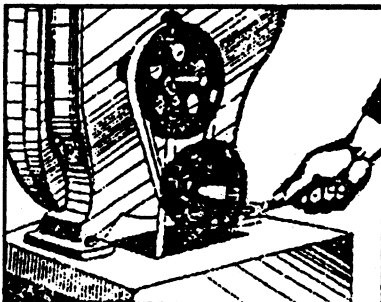

Fig. 11

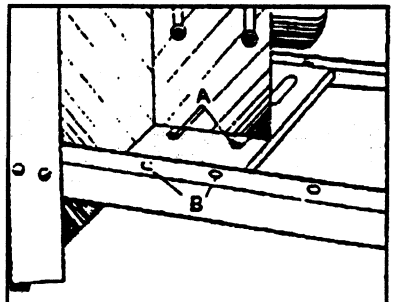

Fig. 10

Bandsaw installation

Use four screws and washers to fix bandsaw base on the stand top. Fig. 11.

Assembling Belt And Pulley Guard

Place the belt and pulley guard(B) Fig. 12, on the top shelf over the belt opening. Use the four round head screws(C). to fasten in place. Place door(D) Fig.6. on hinges.

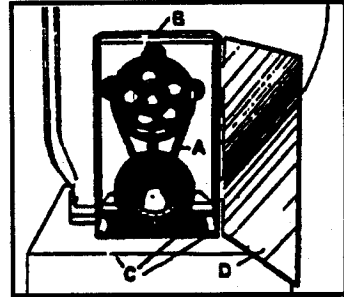

Fig. 12

Table installation

Locate the assembled nut of the trunnion bracket(A) with two screws (B) and washers. Table supporting screw(C) is adjustable to support table properly. Fig. 13.

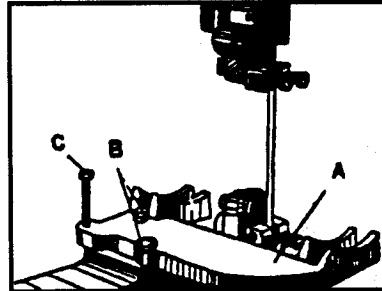

Fig. 13

Table insert

Place table insert (A) Fig. 14. In the hole provided in the table making sure the pin in the table engages one of the indents in the table insert.

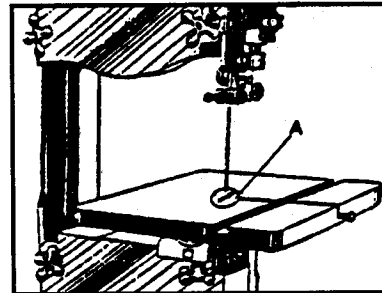

Fig.14

Tilting the Table

The table on your band saw can be tilted 45 degrees to the right and 10 degrees to the left. To tilt the table, loosen the two star wheels(A) Fig. 15. tilt the table to the desired angle and tighten the two star wheels (A).

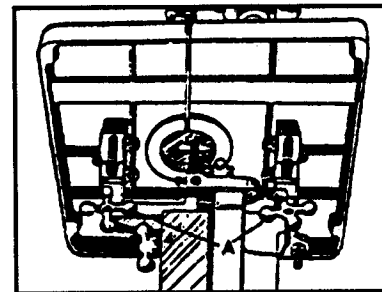

Fig.15

Assembling Table

Move table when place table insert(A) Fig. 14 to make sure the blade be in the center of (A).

Tighten the Six Hex. Hd. Cap screw(C) Fig. 15.

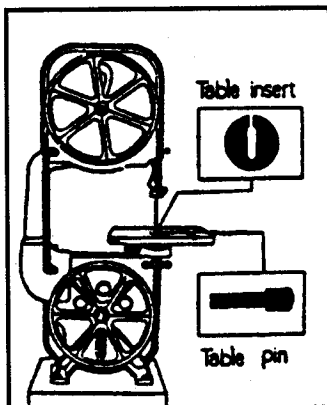

Fig.16

How to Change Blade(Fig. 16)

Take off table insert, pin. Remove wheels guards(upper and lower).

Release blade tension completely. Take off blade carefully.

Replace with new blade. Beware of the direction of the blade, the teeth should be facing operator and point downward. (See Fig. 16 - 1 No. page 7)

Adjust blade tracking and tension.

Replace with new blade. Beware of the direction of the blade, the teeth should be facing operator and point downward.
Adjust blade tracking and tension See "Adjustments" Fig. 16-1

90 Degree Table Adjustment

Your band saw is equipped with an adjustable stop to insure that the table is at 90 degrees to the blade. (Fig. 17)

To adjust:

Tilt the table to the right slightly.

Place the stop on the adjusting screw.

Tilt the table until it is at 90 degree to the blade, making sure by placing a square on the table and against the blade.

When the table is at 90 degrees to the blade, the stop should come into contact with the bottom of the table. If an adjustment is necessary, loosen nut, and turn adjusting screw until the stop contacts the table.

It is necessary to remove the stop, when tilting the table to the left.

Adjusting Blade Tension

On the back of the upper wheel there is a slide bracket to get the proper tension for various widths of blades with the blade on the wheels, turn the star wheel (A) Fig. 18 to raise or lower the wheel until you provide the right tension to your blade. Correct belt tension is obtained when there is approximately 1" (25.4mm) deflection in the center span of the pulleys with light finger pressure. Over straining is a common cause of blade breakage and other unsatisfactory blade performance. Relax the tension when the machine is not in use.

Tracking The Blade

After tension has been applied to the blade, revolve the wheels slowly forward by hand and watch the blade (A) Fig. 19 to see that it travels in the center of the upper tire. If the blade begins to creep toward the front edge, turn the knob to the left and this will tilt the top of the wheel toward the back of the machine and will draw the blade toward the center of the tire. If the blade creeps toward the back edge, turn the knob to the right. Adjust the knob (B) only a fraction of a turn at a time. Never track the blade while the machine is running.

Adjusting Upper Blade Guide Assembly

The upper blade guide assembly (D) Fig. 19, should always be set as close as possible to the top, surface of the material being cut by loosening lock handle (C) and moving the guide assembly (D) to the desired position.

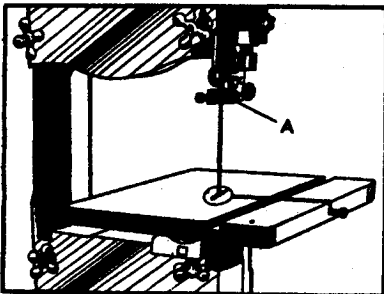

Fig.20

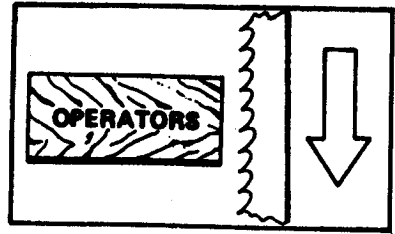

Fig.16-1

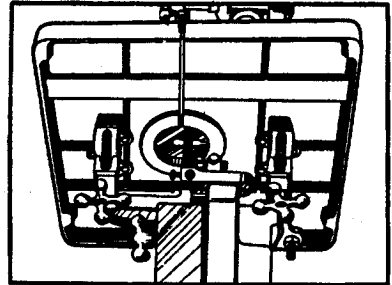

Fig.17

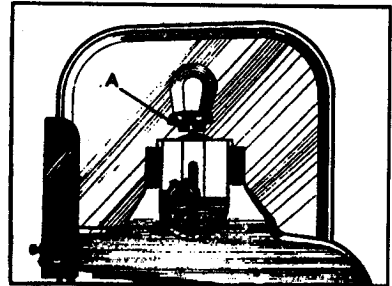

Fig.18

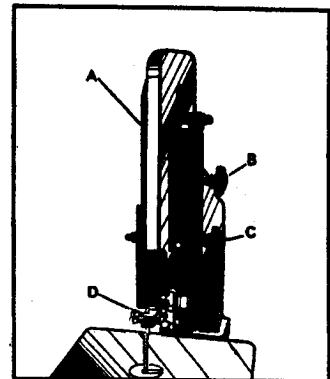

Fig.19

The upper blade guide assembly should also be adjusted so that the blade guides (A) Fig. 20, are flat with the blade.

Adjusting Upper Blade Guides And Blade Support Bearing

The upper blade guides and blade support bearings are adjusted only after the blade is tensioned and tracking properly. To adjust proceed as follows:

The upper blade guides (A) Fig. 21. are held in place by means of the set screws (B). Loosen the set screws (B) to move the guides (A) as close as possible to the side of the blade, being careful not to pinch the blade. Then tighten the knob screw (B).

The upper blade support bearing (C) Fig. 21. prevents the blade from being pushed too far to the back which could damage the set in the saw teeth. The support bearing (C) should be set $1/64"$ (0.4m/m) behind the blade by loosening screw (D) to move the support bearing (C) in or out. The blade support bearing (C) should also be adjusted so the back edge of the blade overlaps the outside diameter of the ball bearing by about $1/16"$ (1.6m/m). The bearing (C) is set on an eccentric and to change position remove screw (D) and bearing (C) Fig. 21. Loosen screw (D) and reposition shaft that bearing (C) is attached to.

Adjusting Lower Blade Guide And Blade Support Bearing

The lower blade guides and blade support bearing should be adjusted at the same time as the upper guides and bearing as follows:

Loosen the two screws (B) Fig. 22, and move the guides (A) as close as possible to the side of the blade, being careful not to pinch the blade. Then tighten screws (B).

The lower blade support bearing (C) Fig. 22. should be adjusted so it is about $1/64"$ (0.4m/m) behind the back of the blade by turning the hex screw (D).

To get appropriate tension, use 10 Lbs. pressure on the belt for the distance of $1/2"$ (13mm) $\pm 10\%$. Close pulley, stand covers.

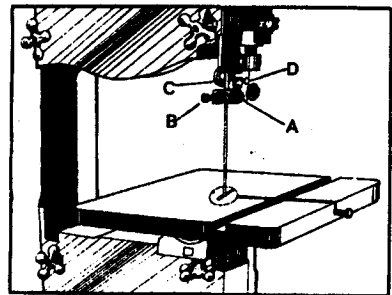

Fig. 21

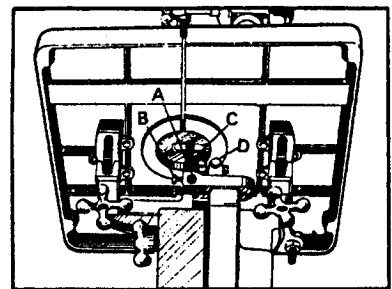
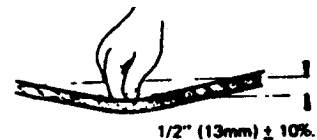

Fig. 22



CHANGING BLADES

To change blades, proceed as follows:

1. Remove the upper and lower wheel guards.
2. Release tension on the band saw blade.
3. Remove the table adjustment pin and table insert.
4. Slip the blade off the wheel and guide it out through the slot in the table.
5. To install a new blade, reverse the above procedure.

BAND SAW BLADES

A band saw blade is a delicate piece of steel that is subjected to tremendous strain. You can obtain long use from a band saw blade if you give it fair treatment. Be sure you use blades of the proper thickness, width and temper for the various types of material to be cut.

Always use the widest blade possible. Use the narrow blades only for sawing small, abrupt curves and for fine delicate work. This will save blades and will produce better work. Band saw blades may be purchased, welded, set and sharpened ready for use. For cutting wood and similar materials we can supply them in widths of 1/8" (3.2m/m), 3/16" (4.8m/m), 1/4" (6.4m/m), 3/8" (9.5m/m), 1/2" (12.7m/m), 3/4" (19m/m).

File and set the wood cutting blades whenever you find it requires pressure to make them cut. If a blade is broken it can be brazed or welded; however, if it has become badly work-hardened it will soon break in another place. If you are not equipped to file, set and braze or weld blades take them to a saw filer for reconditioning. Under average conditions, blades should be resharpened after 4 hours of operation.

Any one of a number of conditions may cause a band saw blade to break. Blade breakage is, in some cases, unavoidable, being the natural result of the peculiar stresses to which such blades are subjected. It is, however, often due to avoidable causes, most often to lack of care or judgement on the part of the operator in mounting or adjusting the blade or guides. The most common causes of blade breakage are: (1) faulty alignments and adjustments of the guides. (2) forcing or twisting a wide blade around a curve of short radius. (3) feeding too fast. (4) dullness of the teeth or absence of sufficient set. (5) excessive tightening of the blade. (6) top guide set too high above the work being cut. (7) using a blade with a lumpy or improperly finished braze or weld and. (8) continuous running of the saw blade when not in use for cutting.

New blades for the standard 14" (356m/m) Band Saw are 93 1/2" (2375m/m) long. The adjustment will accommodate blades up to a maximum length of 94" (2388m/m) and to a minimum length of 91 1/2" (2324m/m). When equipped with the No. 28 - 984 Height Attachment, new blades should be 105" (2667m/m) long; maximum and minimum lengths are 106" (2692m/m) and 103 1/2" (2629m/m).

OPERATING THE BAND SAW

Before starting the machine, see that all adjustments are properly made and the guards are in place. Turn the pulley by hand to make sure that everything is correct BEFORE turning on the power.

Keep the top guide down close to the work at all times. Do not force the material against the blade too hard. Light contact with the blade will permit easier following of the line and prevent undue friction, heating and workhardening of the blade at its back edge.

KEEP THE SAW BLADE SHARP and you will find that very little forward pressure is required for average cutting. Move the stock against the blade steadily and no faster than will give an easy cutting movement.

Avoid twisting the blade by trying to turn sharp corners. Remember you must saw around corners.

CUTTING CURVES

When cutting curves, turn the stock carefully so that the blade may follow without being twisted. If a curve is so abrupt that it is necessary to repeatedly back up and cut a new kerf, either a narrow blade is needed or a blade with more set is required. The more set a blade has, the easier it will allow the stock to be turned, but the cut is usually rougher than where a medium amount of set is used. In withdrawing the piece being cut, in order to change the cut, or for any other reason, the operator must be careful that he does not accidentally draw the blade off the wheels. In most cases it is easier and safer to turn the stock and saw out through the waste material, rather than try to withdraw the stock from the blade.

HOW TO ORDER REPLACEMENT PARTS

Even quality built tools such as the power tool you have purchased, might need occasional replacement parts to maintain it in good working condition over the years. To order replacement parts, contact or write your distributor.

Please give the following information:

1. Model No. and Serial No. and all specifications shown on the Model No. / Serial No. Plate.
2. Part number or numbers as shown in the Replacement Parts list supplied with your power tool.
3. A brief description of the trouble with the power tool.

TECHNICAL DATA

SPEED	SINGLE	TWO	FOUR	
SPINDLE PULLEY (A)				
MIDDLE PULLEY (B)				
MOTOR PULLEY (C)				
SPINDLE SPEED R.P.M.(50HZ/60HZ)	616 · 748	173 · 210	140 · 170	
		637 · 774	238.4 · 289	
			378.2 · 459	
			579.4 · 703	
SAW BLADE m/min	681 · 827	191 · 232.1	154.7 · 187	
		704 · 855.4	263.4 · 317.9	
			418.0 · 505	
			640.3 · 773	
BELT	A - C(A1250)	A-B1 B2-C1(A560 A900)	A-B1 B5-C1(A560 A900)	
		A-C2(A1250)	A-B1 B4-C2(A560 A900)	
			A-B1 B3-C3(A560 A900)	
			A-B1 B2-C4(A560 A900)	

Press sown (A) when adjust from single speed to four speed. However, remember to pull out (A) when adjust to five speed (A-C2).

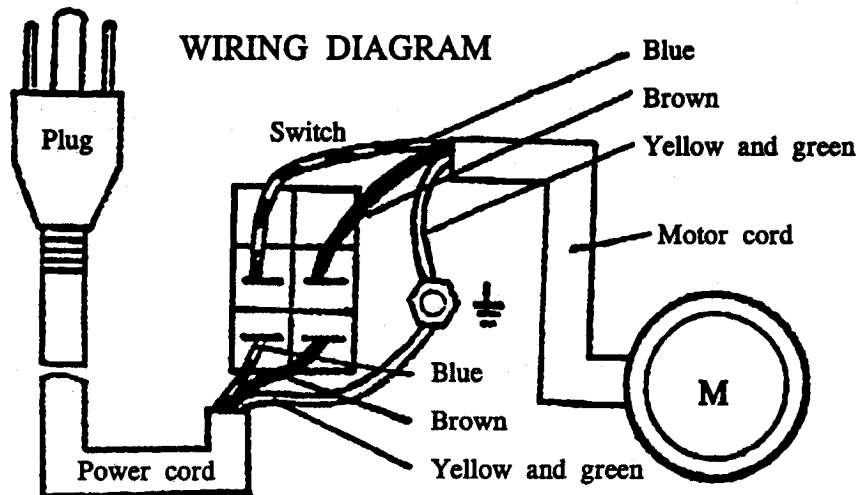

TROUBLE SHOOTING GUIDE

<p>Problem: Motor won't start.</p>	<ul style="list-style-type: none"> (a) Band Saw is not plugged in. (b) Household circuit has blown fuse or open circuit breaker (c) Power cord is damaged. Replace. (d) Switch is not in "on" position. (e) Motor requires service.
<p>Band Saw blade does not move although motor is running.</p>	<ul style="list-style-type: none"> (a) Blade tension knob is not tight. Turn motor off. Tighten knob. Restart band saw. (b) Blade has slipped off pulley wheel. Open cover housing and check. (c) Blade is broken. Replace blade.
<p>Blade will not cut or cuts slowly.</p>	<ul style="list-style-type: none"> (a) Teeth have been dulled by contact with hardened steels or long usage. Replace blade. (b) Use higher speed setting (for wood). (c) Blade mounted backwards.
<p>Sawdust fills up inside of band saw.</p>	<ul style="list-style-type: none"> (a) This is normal—clean out periodically. (b) Remove cover housing. Use vacuum cleaner to remove sawdust.
<p>Sawdust in motor housing.</p>	<ul style="list-style-type: none"> (a) Use vacuum cleaner nozzle on air intake and exhaust grilles. (b) Keep workplace cleaner. Clean up excess sawdust frequently.
<p>Unable to get blade to track in driver of wheel.</p>	<ul style="list-style-type: none"> (a) Backing bearing not properly adjusted. (b) Tension wheel not properly adjusted. (c) Bad blade, Replace blade.

ASSEMBLY DIAGRAM & PARTS LIST

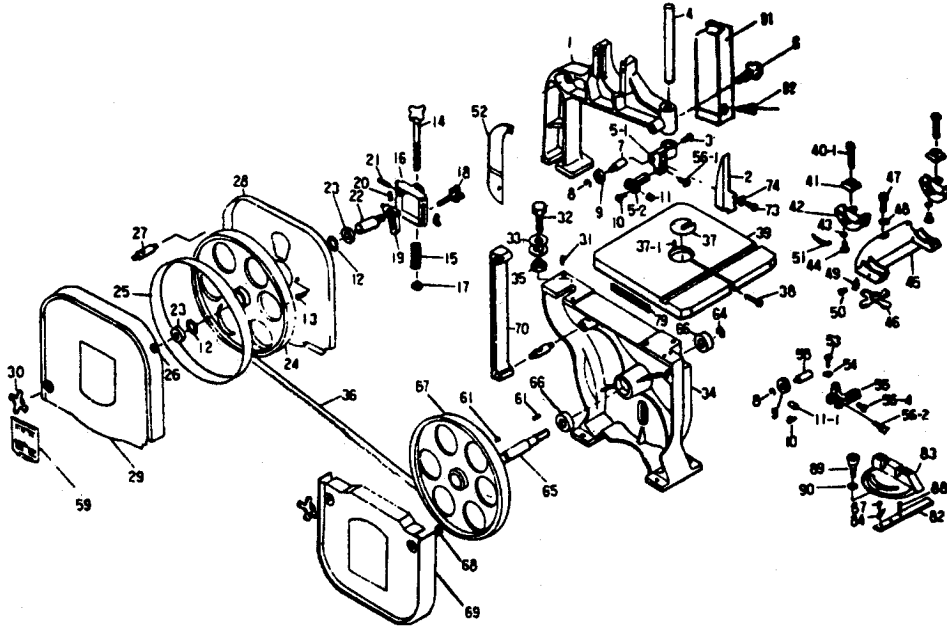

Part No.	Description	Q'ty	Part No.	Description	Q'ty
110001	Upper Frame Arm	1	100043	F. Washer	6
100002	Upper Wheel Saw Guard	1	100044	H. Bolt	6
100003	H. Bolt	1	110045	Trunnion Support Bracket	1
110004	Guide Post	1	110046	Knob Nut	2
100005-1	A. Upper Support Bracket Post	1	110047	H. Bolt	2
100005-2	B. Support Bracket for Upper Guide	1	110048	Spring Washer	2
110006	Knob	1	110049	Pointer Rod	1
100007	Upper Spacing Sleeve	2	100050	P. H. Screw	1
100008	Stop Ring	1	100051	Scale	1
100009	Bearing 6200zz	2	100052	Side Cover	1
100010	H. Bolt	4	100053	H. Bolt	2
100011	Blade Guide	2	100054	F. Washer	2
100012	Retaining Ring	2	110055	Lower Support Bracket Post	1
100013	P. H. Screw	2	100056-1	Knob Screw	2
100014	Blade Adjusting Screw	1	100056-2	Knob Screw	1
100015	Coil Spring	1	100056-4	Knob Screw	1
100016	Upper Wheel Sliding Brkt	1	100057	Nut	1
100017	Square Nut	1	110058	Blade Guide	2
100018	Knob Screw	1	110059	Name Plate	1
100019	Upper Wheel Shaft Hinge	1	100061	Key	2
100020	Spring Pin	1	100062	H. Bolt	1
100021	Steel Pin	2	100064	Retaining Ring	1
100022	Upper Wheel Shaft	1	110065	Lower Wheel Shaft	1
100023	Bearing 6202Z	2	100066	Bearing 6204z	2
100024	Upper Wheel	1	100067	Lower Wheel	1
100025	Wheel Protector	2	100068	Nut	1
100028	Nut	1	100069	Lower Wheel Guard	1
100027	Stud	4	100070	Blade Guard	1
100028	Upper Wheel Guard (Inner)	1	100071	Motor Pulley	1
100029	Upper Wheel Guard (Outer)	1	100072	Set Screw	1
100030	Knob Nut	4	100073	H. Bolt	2
100031	Spring Pin	4	100074	F. Washer	2
100032	H. Bolt	1	100079	Table Label	1
100033	F. Washer	2	100082	Scale	1
110034	Base	1	100083	Guide Plate	1
100035	Nut	1	100084	Pointer	1
100036	Saw Blade	1	100087	P. H. Screw	1
100037	Table Insert	1	100088	Spring Pin	1
100037-1	Spring Pin	1	100089	Knob	1
100038	Table Pin	1	100090	F. Washer	1
100039	Table	1	100091	Guard For Upper Guide Post	1
100040-1	H. Bolt	2	100092	Kex Bolt	1
100041	Trunnion Clamp shoe	2			
100042	Trunnion	2			

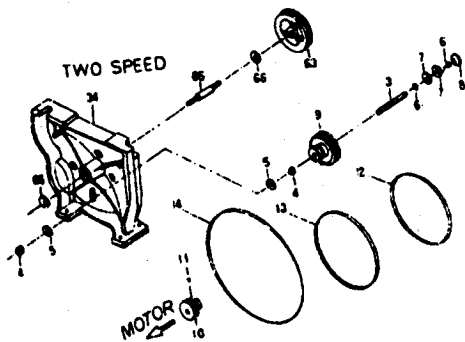
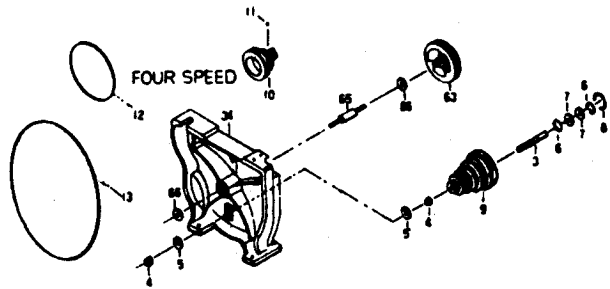
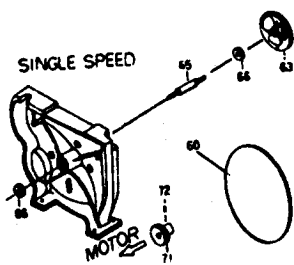
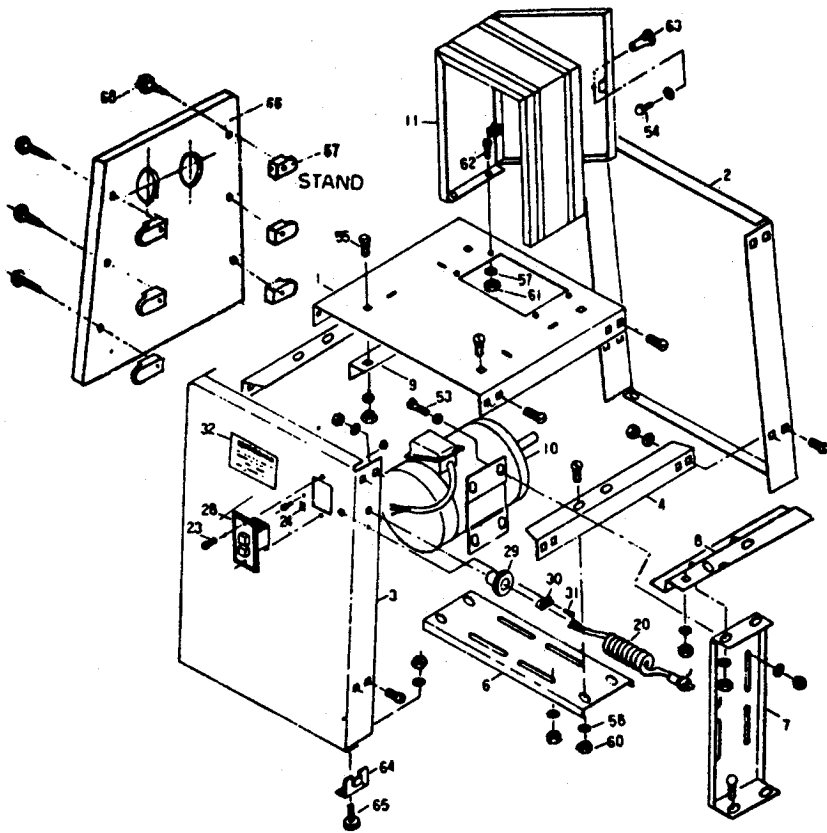

Part No.	Description	Q'ty	Part No.	Description	Q'ty
STAND PARTSLIST			TWO SPEED PARTS LIST		
110101	Face Plate	1	110034	Base	1
110102	Stand Legs (A)	1	110063	Belt Pulley	1
110103	Stand Legs (B)	1	110065	Shaft	1
110104	Supporting Plate	2	100066	Bearing 6204z	2
110106	Base Motor Plate	1	120203	Shaft	1
110107	Motor Fastening Plate	1	120204	Nut	2
110108	Motor Plate Bracket	1	120205	F. Washer	2
110109	Stiffening Plate	1	120206	Retaining Ring	2
110110	Motor	1	120207	Bearing 6202z	2
110111	Pulley Box	1	120208	Retaining Ring	1
110120	Power Cord	1	120209	Middle Pulley	1
110123	P. H. Screw	2	120210	Motor Pulley	1
110124	Grounding Lable	1	120211	Set Screw	1
110128	Switch	1	120212	V- Belt A22	1
110129	Gord Bushing	1	120213	V- Belt A38	1
110130	Bush	1	120214	V- Belt A50	1
110131	P. H. Screw	1	FOUR SPEED PARTS LIST		
110132	Warning Lable	1	110034	Base	1
110153	H. Bolt	4	110063	Belt Pulley	1
110154	H. Bolt	4	110065	Shaft	1
110155	Square Neck Bolt	28	100066	Bearing 6204z	2
110157	Spring Washer	4	120203	Shaft	1
110158	F. Washer	49	120204	Nut	2
110160	Nut	41	120205	F. Washer	2
110161	Nut	4	120206	Retaining Ring	2
110162	P. H. Screw	4	120207	Bearing 6202z	2
110163	Knob	1	120208	Retaining Ring	1
110164	L. Shape Fixed Plate	4	140409	Middle Pulley	1
110165	Pad	4	140410	Motor Pulley	1
110166	Retaining Plate	2	140411	Set Screw	1
110167	Presser Block	12	140412	V- Belt A22	1
110168	Self-tapping Screw	12	140413	V- Belt A38	1
SINGLE SPEED PARTS LIST					
110060	V. Belt A. 50	1			
110063	Belt Pulley	1			
110065	Shaft	1			
110066	Bearing 6204z	2			
110071	Motor Pulley	1			
110072	Set Screw	1			

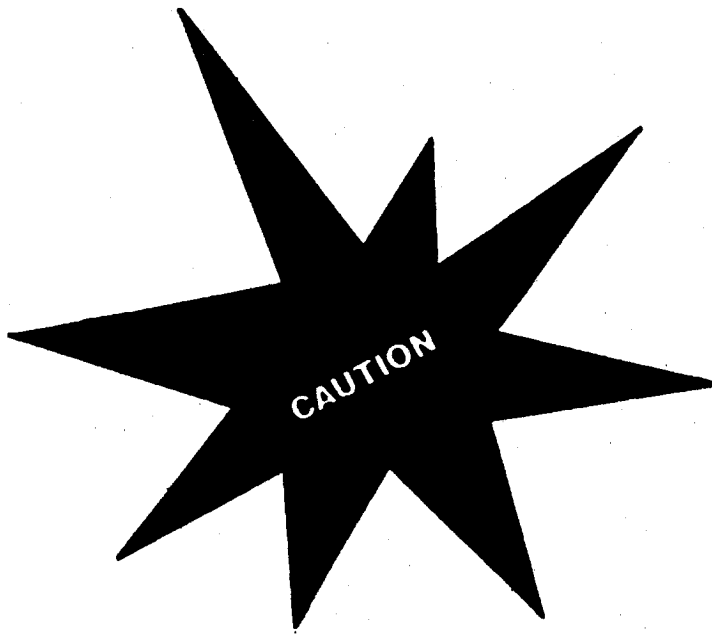

WARNING

**or Your Own Safety Read
Instruction Manual Before
Operating Saw**

- 1.Wear eye protection.**
- 2.Do not remove jammed cut off pieces until blade has stopped.**
- 3.Maintain proper adjustment of blade tension, blade guides, and thrust bearings.**
- 4.Adjust upper guide to just clear workpiece.**
- 5.Hold workpiece firmly against table.**
- 6.“Never operate any machine tool without all proper safety guards in place and in good working condition.”**